

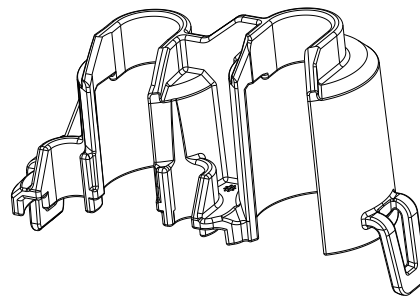

REV	REVISION DETAILS	ECO	DATE	BY	ABY
0	INITIAL RELEASE	NP-006416	10-28-2024	JWK	JML



ISO VIEW  
FOR REF ONLY

**CONFIDENTIAL**

The information contained in this document is the property of GEP Power Products. It is not for public disclosure. Possession of the information does not convey any right to loan, sell or disclose the information. Unauthorized reproduction or use of the information is prohibited. This document is to be returned to GEP Power Products upon completion of the purpose for which it is loaned or upon request.

 CRITICAL DIMENSIONS ON FEATURES TO BE CHECKED DURING ANY SET-UP ADJUSTMENTS, TOOL CHANGES, OR ANNUAL MAINTENANCE ON TOOLING.

 DIMENSIONS OR FEATURES TO BE CHECKED FROM RUN-TO-RUN

TOLERANCES UNLESS OTHERWISE SPECIFIED

THIRD ANGLE PROJECTION



METRIC TOL

ENGLISH TOL

ANGULAR TOL =  $\pm 2^\circ$   
FRACTION TOL =  $\pm 1/64$  IN

1 PL DEC. =  $\pm .25$   
2 PL DEC. =  $\pm .13$

2 PL DEC. =  $\pm .01$   
3 PL DEC. =  $\pm .005$

DIMENSIONS INSIDE PARENTHESES OR CONTAINING "REF" ARE FOR REFERENCE ONLY.

COPYRIGHT - GEP POWER PRODUCTS

This is unpublished work. The disclosure of this work is limited to a select personnel. Further dissemination or disclosure to the public is PROHIBITED. This unpublished work is protected by Federal Copyright law and all rights thereunder are reserved by GEP Power Products.

		16830 Pheasant Drive Brookfield, WI 53005		
PART NO:		SC38-2015A-B003 (SALES)		
DESCRIPTION:		TPA - FRH - MAXI ISO RELAY AND MAXI FUSE - A SIDE		
CUSTOMER:		STANDARD		
METRIC (MM)	REV	SHEET	SCALE	SIZE
	0	1 OF 2	1:1	A

2

3

A

A

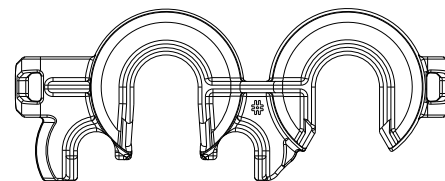

B

B

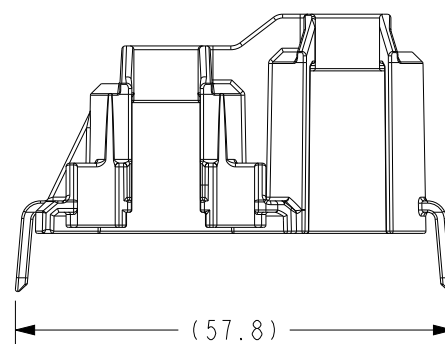
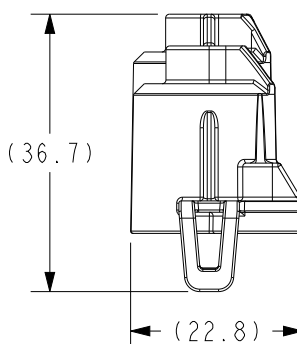

C

C

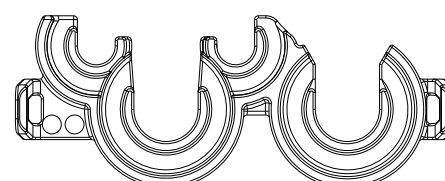

- NOTES:
1. MATERIAL: NYLON
  2. COLOR: BLUE
  3. RoHS AND REACH COMPLIANT

		16830 Pheasant Drive Brookfield, WI 53005		
		PART NO: SC38-2015A-B003 (SALES)		
DESCRIPTION:		TPA - FRH - MAXI ISO RELAY AND MAXI FUSE - A SIDE		
CUSTOMER:		STANDARD		
METRIC (MM)	REV	SHEET	SCALE	SIZE
	0	2 OF 2	1:1	A

2

3